





BARRE D'APPUI PRESTIGIO PLUS



Barre de sécurité en forme de L sans bride en acier inoxydable AISI 304. Ø 32 mm. Supports de montage en aluminium chromé, embouts en ABS chromé. Disponible en version droitier ou gaucher. Disponible en différentes couleurs

Cette barre d'appui est idéale pour une utilisation dans les douches et les sanitaires, pour une sécurité maximale de l'utilisateur.

- Application: maisons privées, résidences-services, centres de soins et hôtels, etc....
- Dimensions: AxBxC (mm) 406x82x403
- Capacité de charge: verticale 150kg

• Couleurs:

Standard finishes

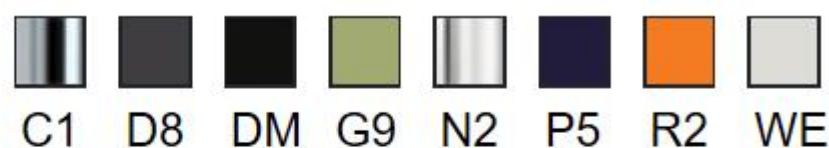

Special finishes









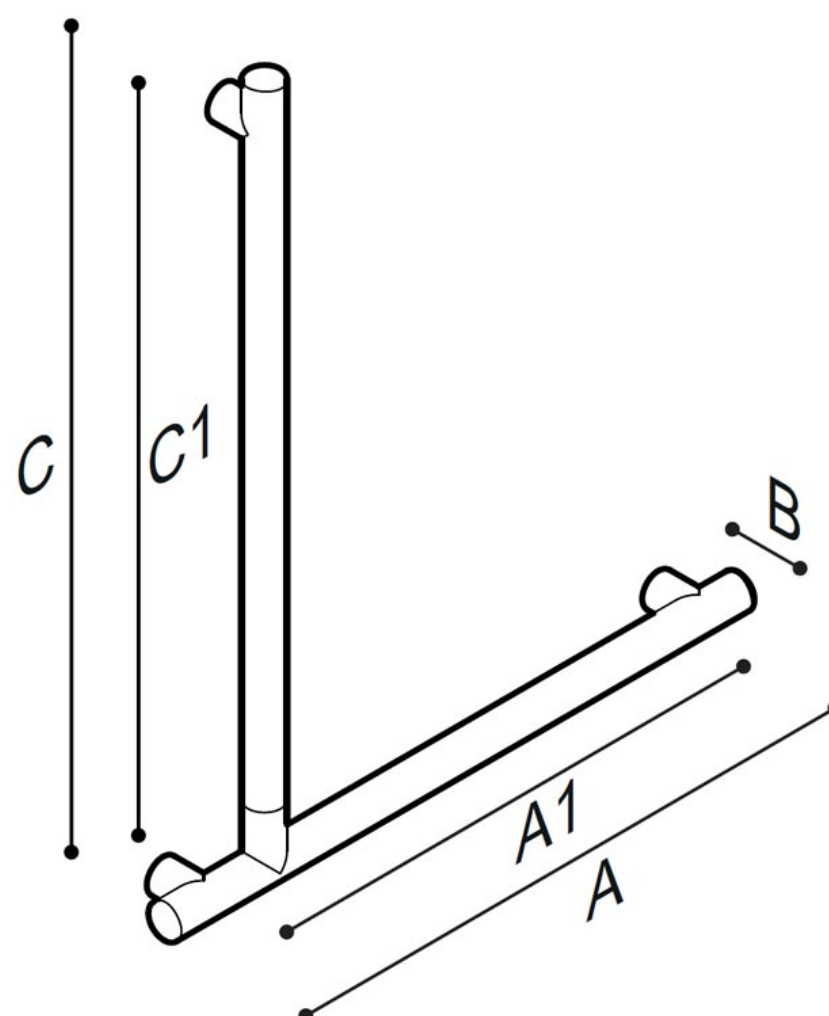

BARRE D'APPUI PRESTIGIO PLUS



90°

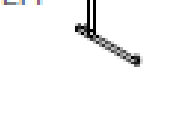

Artn°	AxBxC (mm)	C1 (mm)	poids	Charge	
Epoxy-polyester powder finish and surface treatments: D8-WE-P5-R2-G9-DM-N2					
RH 	G18UBR34xx	406x82x403	300x334	1.20	150
LH 	G18UBL34xx	406x82x403	300x334	1.20	150
Electro-chemical treatments: C1 chrome-plated					
RH 	G18UBR34xx	406x82x403	300x334	1.20	150
LH 	G18UBL34xx	406x82x403	300x334	1.20	150
Electro-chemical treatments: E1-E2-E3-E4-E5-E6-E7 [ONLY ON REQUEST]					
RH 	G18UBR34xx	406x82x403	300x334	1.20	150
LH 	G18UBL34xx	406x82x403	300x334	1.20	150



BARRE D'APPUI PRESTIGIO PLUS 90°

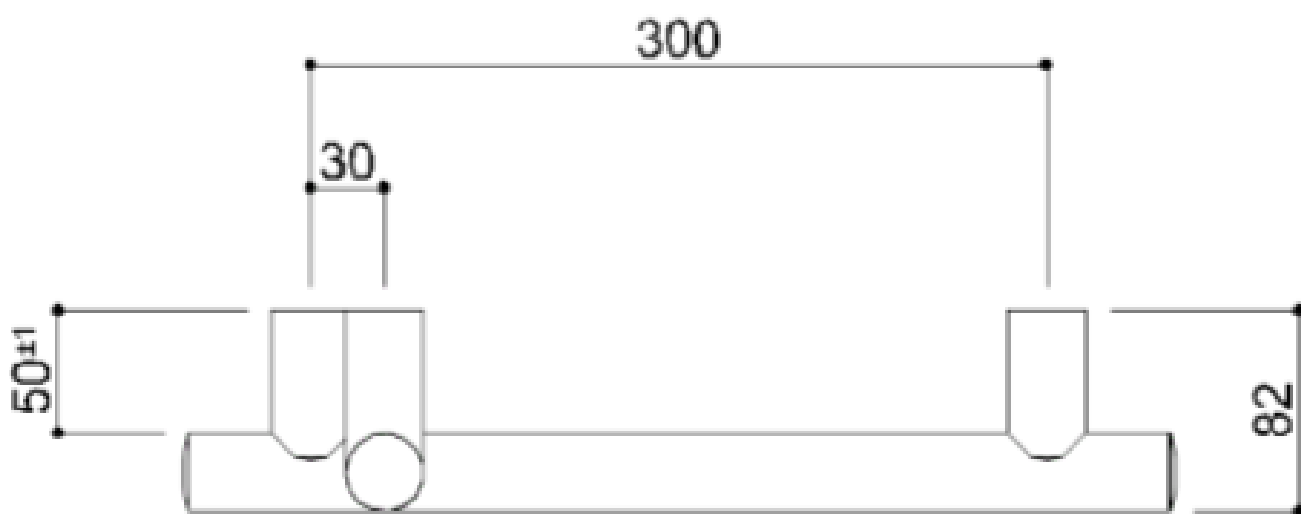
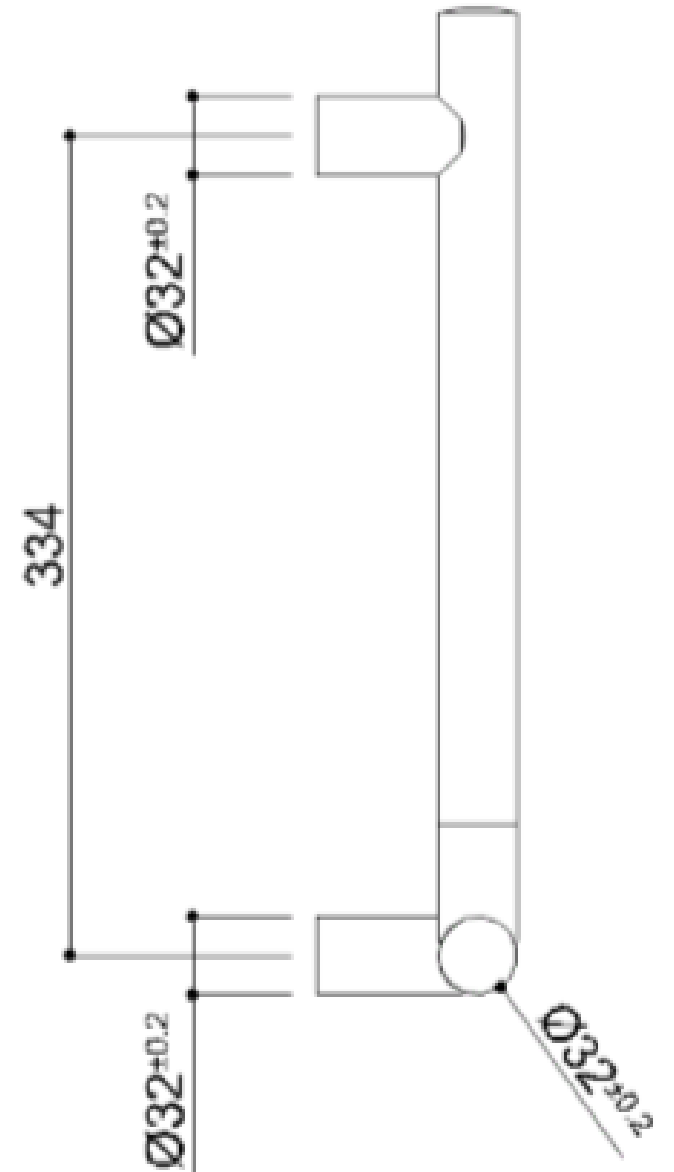
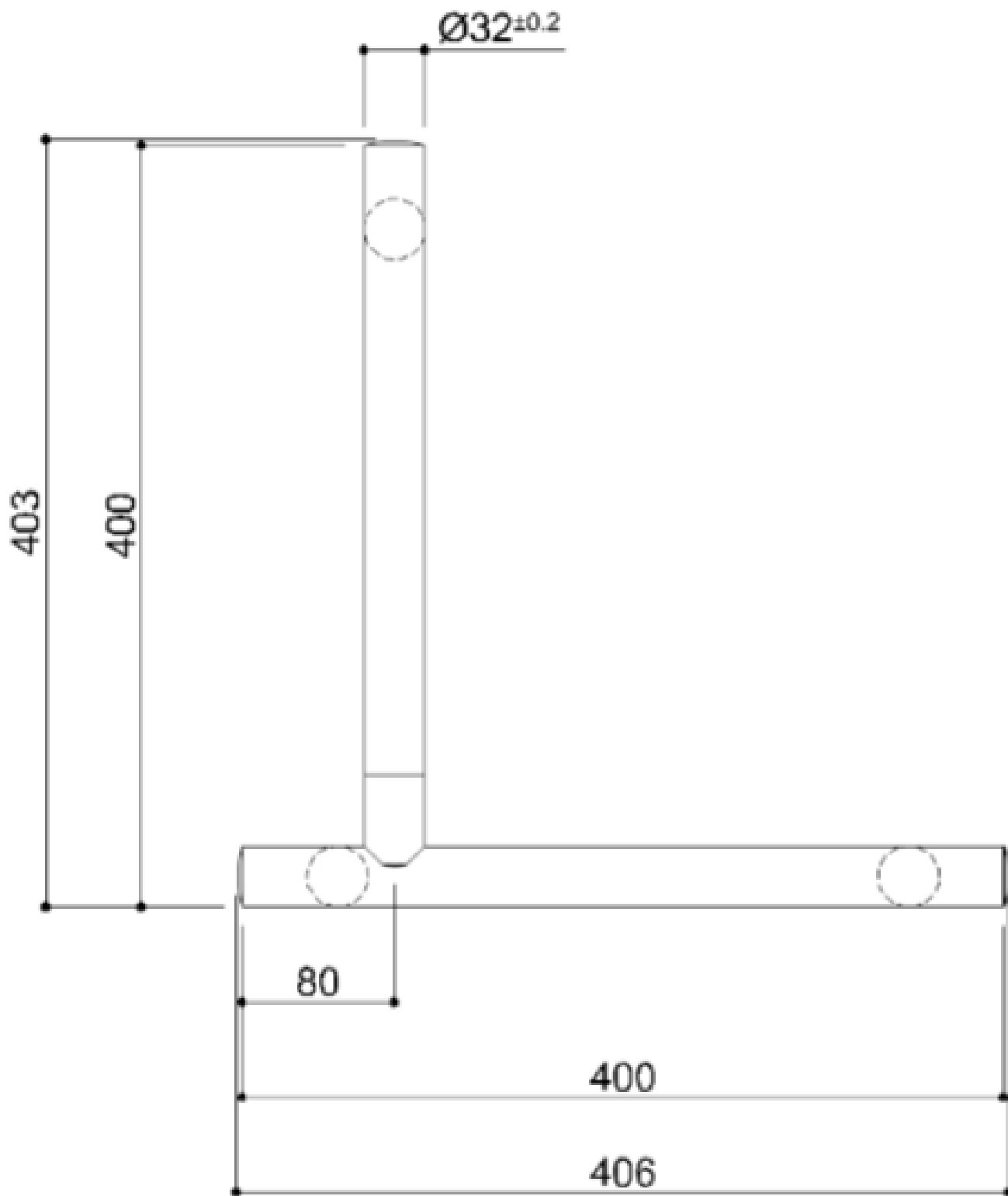



D8 Oxide grey



W2 Warm white



N2 Polished